

im1-EXT

Maximum flexibility for smart communication

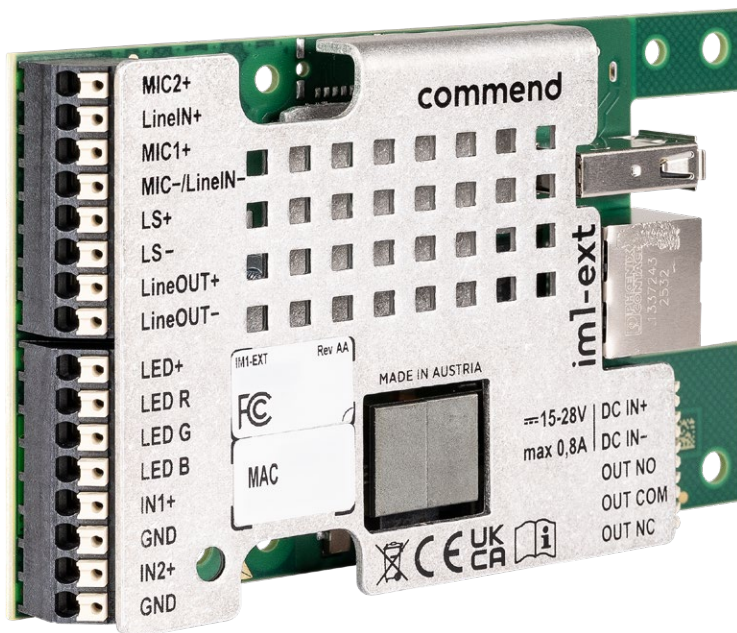

PRELIMINARY

Modular
solution

Fully
IP-based

Ready for
Symphony
Cloud

Future-proof
system

Easy integration into existing systems

The im1-EXT is a cost-effective intercom module based on the powerful Symphony MX platform and offers a future-proof alternative to the classic ET 908. It combines modern technology with economic efficiency and enables a seamless migration to modern communication solutions.

With its open design without housing, the im1-EXT is aimed specifically at integrators looking for a lean and economical solution for existing installations – whether in emergency call stations, barriers or vending machines. Thanks to its robust technology and sophisticated interfaces, the im1-EXT ensures clear and reliable communication – even in noisy and demanding environments.

The design of the module and the connection positions have been designed in such a way that an ET 908 can be easily replaced by the im1-EXT without the need for complex modifications. At the same time, the im1-EXT takes system functionality to a new level: cloud services, modern security standards and reliable communication ensure efficient and secure modernisation of existing OEM systems.

Features and highlights

- Crystal clear sound with up to 20 kHz speech quality and a power of up to 10 W thanks to the latest Smart Audio Amplifier technology
- Special audio functions provide high speech quality in any situation
- OpenDuplex® for natural, hands-free communication
- Compact Intercom module with RJ45 jack for easy installation
- Spring-type terminals enable simple and fast connection of cables
- Easy to expand with add-on equipment via USB
- 2 inputs for floating contacts and 1 relay output

Ready for Symphony Cloud

The device can be connected to Symphony Cloud and use its services. Symphony Cloud is the world's first cloud-based Intercom platform with "Privacy and Security by Design". Visit our website to find out about the services currently available and if they are already offered in your country. [symphony.commend.com](https://www.symphony.commend.com)

Accessories

Loudspeaker module LSM

With the LSM, the device can be equipped with a loudspeaker.



USB I/O module EB1E1A

With the USB I/O module EB1E1A, the device can be expanded with an additional input and a relay output (normally open contact). The EB1E1A can be connected to a free USB port. By doing this, an input as well as a floating, galvanically-isolated output contact is available immediately – e.g. for use with a door opener.



USB I/O module EB8E8A

A device can be quickly expanded with inputs and outputs using the USB I/O module. The total of 8 inputs and 8 outputs of the EB8E8A enable an easily scalable solution. The EB8E8A complies with Commend's strict cyber security guidelines, e.g. for switching outputs. The module is connected using USB.

PRELIMINARY

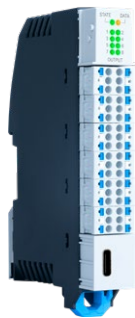

Expansion module EB3E2A-AUD

The EB3E2A-AUD expansion module provides an easy way to expand the I/O and audio capabilities of a device. The expansion module is suitable for any applications where additional inputs and outputs are required. It has three inputs, two output relays and ports for direct connection of an external loudspeaker, external microphones and handset. Line-in and line-out connectors provide additional flexibility. The expansion module can be connected to the device through a USB cable and is immediately available in the system.



Safety switch box IP Secure Connector

The IP Secure Connector provides high performance and high, absolute security, even if the connected device is located outdoors: If an unauthorised attempt is made to remove the device, e.g. to access the connected Ethernet cable, the IP Secure Connector interrupts the connection to the device and LAN. This ensures that it is neither possible to access the network nor to open a door or gate. Furthermore, the IP Secure Connector provides power supply in form of PoE and has two inputs and three outputs.



Power injector PA 25W POE-DC

In applications where PoE sourcing equipment is not available, the optional power injector PA 25W POE-DC offers a compact, convenient solution. It supports a wide DC input range (24–48 V) and is IEEE 802.3af/at compliant. The power injector connects easily and conveniently to a device through an Ethernet cable.



Microphone MIC 480

The MIC 480 is a high-quality microphone specially designed for harsh outdoor environments. It can be installed for use with Intercom stations in parking columns, ticket machines or elevator panels or used as a customer-side microphone for counter intercoms.



Induction loop kit AFIL-USB

With the AFIL-USB, a device can easily and quickly be equipped with an induction loop amplifier module.



Loudspeaker LS8, LS15 or AL 10-16

With the LS8, LS15 or AL 10-16 (see image), a device can be equipped with an external loudspeaker.



RGB status indication LED3

The LED3 is designed for installation in an LSM for status indication.

PRELIMINARY

System overview

Operation with Symphony Mesh

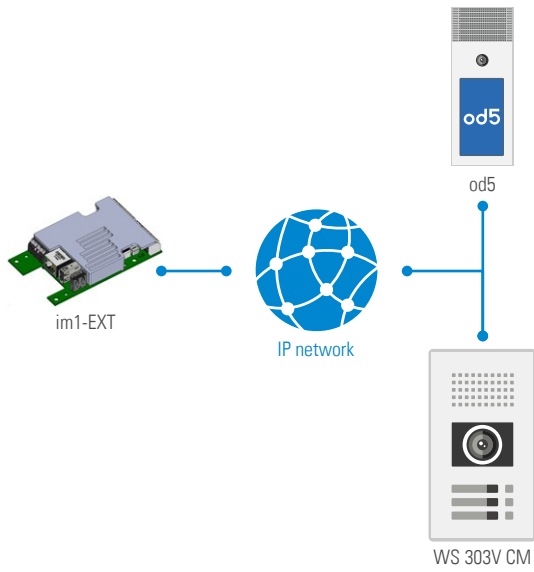

Operation with Symphony On-Prem

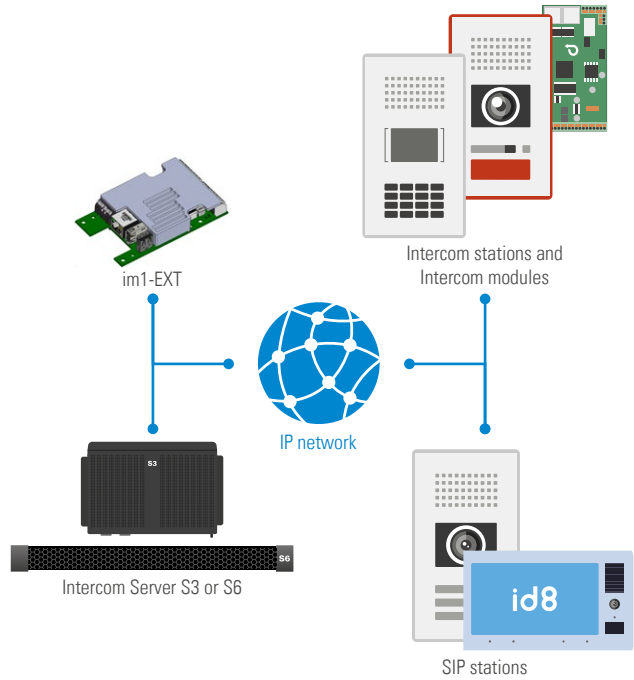

Application example

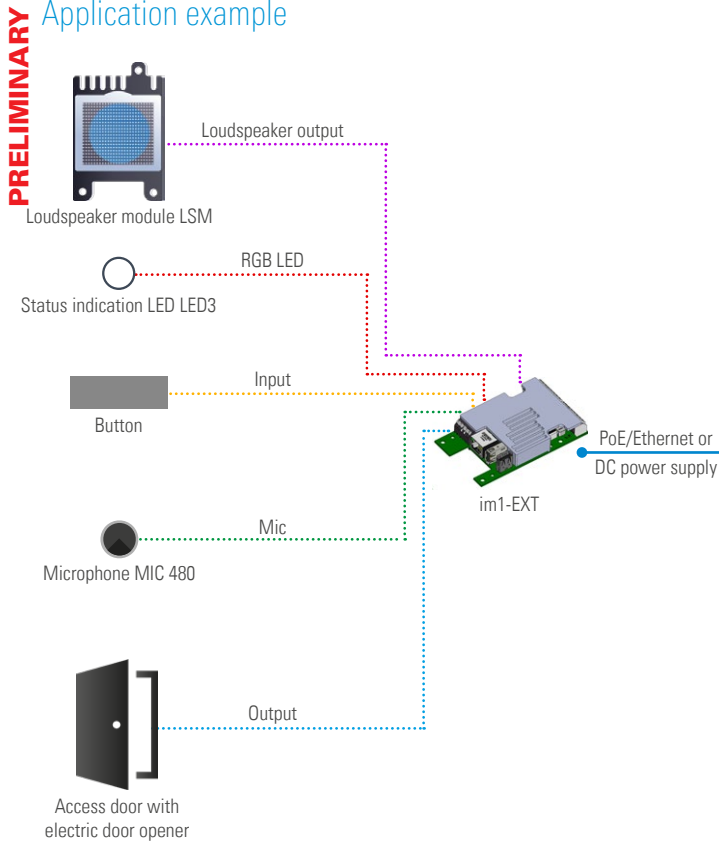

Operation with Symphony Cloud

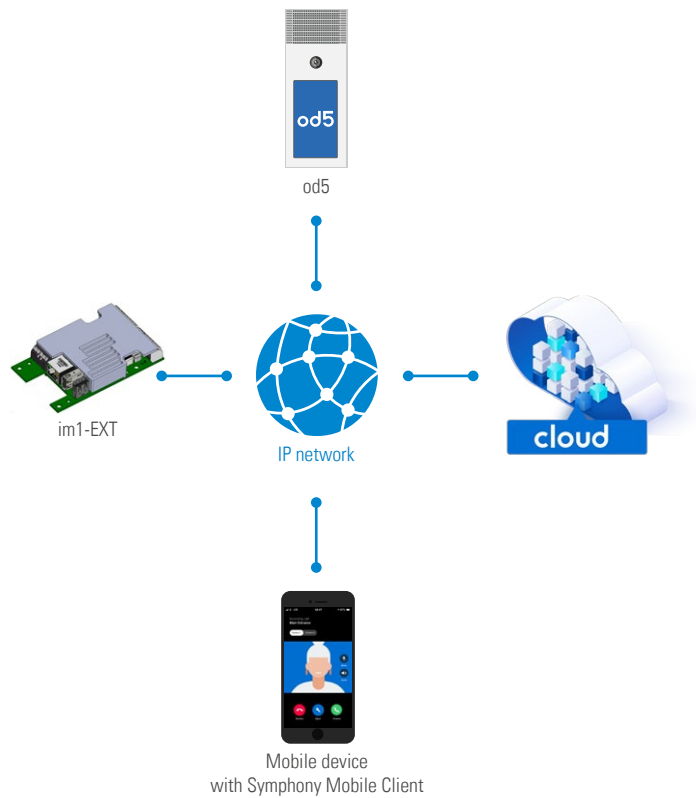

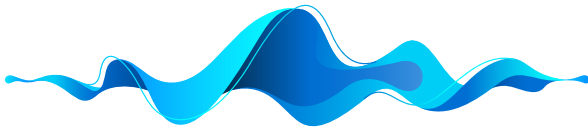

CERTIFIED
ACC. TO
ISO 27001
IEC 62443-4-1

Passion meets audio

Ultimate speech intelligibility

Because every word matters, high speech intelligibility is crucial in security and communication solutions. In everyday life, it enables natural and brilliant communication; in operational processes, it ensures improved efficiency and in an emergency often buys life-saving time.

AI CLEANS VOICE FROM NOISE

Noise cancellation

Revolutionary **AI-based** noise cancellation, powered by our deep neural networks, transforms your audio experience. Genuine, device-specific audio training data enables us to easily distinguish between speech and background noise and effectively eliminate unwanted sounds (wind, traffic, background talk), providing you with pristine, uninterrupted communication.

Echo cancellation

Our advanced echo cancellation technology leverages the power of Commend's proprietary **deep neural networks** to deliver unparalleled clarity. Experience smooth and natural conversations without any noticeable echoes or delays, ensuring effective communication every time.

Dynamic volume adjustment

IVC (Intelligent Volume Control) automatically adjusts the loudspeaker volume of the Intercom station depending on the environment noise level – because both, too low and too high a volume, significantly reduces speech intelligibility and the user experience.

Hands-free communication through OpenDuplex®

This technology from Commend, combined with highly sensitive microphones as well as a high volume, allows natural and hands-free communication within a unique radius of several metres.

High volume

When there is ambient noise, the Intercom station has sufficient reserves to put out the audio signal of the other party at a higher volume than any distracting background sounds.

Audio functions adding value

- **Loudspeaker-microphone surveillance** – constant availability of Intercom stations while greatly reducing the manual testing effort.
- **Simplex mode** – for applications requiring controlled communication, e.g. security or industrial solutions based on the push-to-talk/release-to-listen principle.
- **Audio monitoring** – fully automated (emergency) call triggering at defined sound pressure levels for more security.
- **Live sound pressure level** – continuous measurement of ambient noise with optional transfer to a management system through SNMP or HTTP (e.g. to visualise noise volumes).
- **Equalizer** – for fine-tuning to ambient acoustic conditions.
- **Public address functions** – as an essential element of a holistic solution approach, announcements can be made or played back at every Intercom station as well as responded to directly.

For more information, visit:
audio.commend.com

Cyber security at Commend

Uncompromising protection against threats

IT infrastructures are facing a growing variety of cyber threats. This means that the defensive capabilities of each product in the system environment are key.

Security is above all a question of trust. At Commend, cyber security as a core competence has always been given a very high priority. From the initial product idea through implementation and operational support, privacy and security by design (PSBD) is the uncompromising target and promise to our customers against which product features and functions must be measured.

Cyber security as top priority

- Commend as well as the hardware and software development process is rigorously certified according to the standard **IEC/ISO 27001** and subject to a company-wide information security management system (ISMS)
- Commend is a member of the **Center for Internet Security (CIS)**
- Commend's Cyber Security Board ensures the handling and transparent communication of security vulnerabilities as well as the strategic hardening of Commend systems
- Commend is certified in accordance with the **IEC 62443-4-1** standard. The Commend development team implements secure communication and automation solutions in agreement with „Security by Design“ guidelines.
- Commend continuously publishes software updates with security patches and improvements

Physical security

- Robust devices and vandal-resistant product versions
- Tamper detection through electromechanical contacts
- USB and port-debugging protection

Network security

- **Standard IEEE 802.1x** for authentication (network access)
- **Standard IEEE 802.1q** for VLANs (network segmentation)
- Commend IP Secure Connector for automatic interruption of the network connection in the event of a tampering attempt

Data security

- **Encrypted and authenticated communication**
- **SIP over TLS v1.2** with secure cipher suites (> 128 bit)
- **SRTP** for tap-proof encryption of voice data
- **X.509 client certificates** for authentication and encryption
- TLS transport encryption for the protocols **HTTPS**, **SIPS** and **MQTT** to protect the web interface, APIs and video

Application security

- Mandatory change of the default password during the first login
- Minimum password length: 12 characters
- Detection of brute-force attacks at login
- Documentation and securing of network ports

Information about the cyber security of other Commend products can be found in the respective data sheets and product manuals.

For more information, visit:
trust.commend.com

im1-EXT

Technical specifications



Technical data

External LED:	1 RGB LED can be connected
Inputs:	2 inputs for floating contacts ¹⁾ (switches, push-buttons, relay outputs, etc.) input states: short, 560, 1k, 1k5, 2k2, 2k7, 3k3, 4k7, 6k8, 8k2, 10k, 15k, 22k, 33k, 56k, open
Output:	1 relay output ²⁾ max. switching voltage: 60 VDC, 30 VAC max. switching current: 2 A max. switching power: 60 W (DC), 37.5 VA (AC) expected electrical life: min. 10 ⁵ (30 VDC/2 A), min. 2 x 10 ⁵ (30 VDC/1 A)
Microphone input:	2 microphone inputs sensitivity (electret condenser microphone): -43 dBV/Pa feeding voltage: 3.3 V at 4.3 kΩ
Line-in:	sensitivity: nom. -10 dBu, max. +14 dBu input impedance: 100 kΩ
Loudspeaker output:	power: 4 W (RMS) at 8 Ω, 7 W (RMS) at 4 Ω, max. 10 W (peak) total harmonic distortion (THD+N): < 0,2% loudspeaker impedance: ≥ 4 Ω
Amplifier:	integrated, highly efficient Smart Audio Amplifier, 10 W
Audio bandwidth:	up to 20 kHz
Audio codecs:	Opus, G.722, G.711 a-law and G.711 u-law
Sound pressure level (with LSM):	max. 98 dB at 0.5 m (1.6 ft)/92 dB at 1 m (3.3 ft)
IT security:	ISO-27001-certified manufacturer, SIP over TLS, SRTP, IEEE 802.1X, HTTPS for accessing the web interface and interfaces, X.509 certificates
Protocols:	IPv4, IPv6, TLS, TCP, UDP, HTTP (RFC 2617, RFC 3310), HTTPS (RFC 2818), RTP (RFC 3550), RTSP (RFC 2326), SIP over TLS, RTP, DHCP, DHCPv6, DNSv4, DNSv6, mDNS, 802.1x EAP-TLS (RFC 5216), 802.1x EAP-MD5 (RFC 2284), SDP (RFC 2327, RFC 4566), SSDP, SIP (RFC 3261), SMTP, SNMPv2c, SNMPv3, SNTpv4 (RFC 5905, Section 14), STUN (classicstun), DTMF Decoding (RFC 2976, RFC 2833, SIP Info), ICMPv6 (Router discovery), MQTT (ISO/IEC 20922)
Operating temperature range:	-40 °C to +70 °C (-40 °F to +158 °F)
Storage temperature range:	-40 °C to +70 °C (-40 °F to +158 °F)
Relative humidity:	up to 95%, not condensing
Connection ³⁾:	spring clamp terminals (conductor cross-section solid/flexible: 0.2–1.5 mm ² , conductor cross-section flexible, with ferrule and without plastic sleeve: 0.25–1.5 mm ² , conductor cross-section flexible, with ferrule and with plastic sleeve: 0.25–0.75 mm ² , AWG 28–AWG 14, stripping length: 8–10 mm/0.31–0.39 in) USB 2.0 (Type A) RJ45 jack for Ethernet and PoE (10/100 Mbit/s)
Power supply:	PoE, IEEE 802.3af/802.3at Type 1 Class 3 ⁴⁾ 12.95 W DC power supply: 24 VDC (15–28 VDC), max. 0.8 A at 15 V, max. 0.54 A at 28 V
Power consumption:	idle: approx. 1.8 W (standalone) max.: ca. 6.7 W ⁵⁾
Cabling:	min. Cat. 5, shielded

Approvals and compliances:	EN 61000-6-2, EN 61000-6-3, EN 55032 Class B, EN 55035, FCC Part 15 Class B, ICES-003 Class B, EN 62368-1 IEC 62368-1 (CB Scheme), UL 62368-1 Listed (E351589) pending
Dimensions (H x W x D):	110 x 65 x 24 mm (4.33 x 2.56 x 0.94 in)
Weight incl. packaging:	approx. 180 g (0.40 lbs)
Optional accessories:	LSM (loudspeaker module) LED3 (status indication LED) LS8, LS15 or AL 10-16 (loudspeaker) AFIL-USB (induction loop kit) EB1E1A (USB I/O module) EB8E8A (USB I/O module) EB3E2A-AUD (expansion module) IP Secure Connector (safety switch box) PA 25W POE-DC (power injector) MIC 480 (microphone)

¹⁾ For the input state "Short", the switch resistance has to be < 280 Ω.

²⁾ The relay output may only be used for ES1/PS2 or SELV circuits. An ES1 circuit according to IEC/EN/UL 62368-1 or a SELV circuit according to IEC/EN 60950-1 must be safely separated (e.g. by double insulation) from a dangerous circuit (e.g. 230 V or 110 V mains circuit) and must not exceed the voltage values 60 VDC or 42.4 VAC_{peak} (30 VAC_{eff}).

³⁾ Connectors (USB, LS+, LS-, LED R/G/B/+, MIC+, LineIn+, MIC-/LineIn-, IN- (GND), IN1+ and IN2+) are PS1-declared and PS1-tested (acc. to EN/UL/IEC 62368-1).

⁴⁾ Backwards compatible with IEEE 802.3af/Class 3.

⁵⁾ With microphone, loudspeaker (4 Ω), volume level "9" (1 kHz sinus signal, 1/8 power), 2.5 W load on the USB 2.0 port, both CPU cores and NPU at 100% load, relay closed and RGB LED with max. brightness.

Extent of supply

- Intercom module
- 4 spacer pins with M3 thread
- Device identification document
- Open source compliance information
- Short reference

System requirements

Server

- VirtuoSIS (min. version 5.0) or
- S3/S6 (min. version 7.1) or
- Compatible SIP server or
- Serverless operation

Configuration software

- Set-UP min. version 2.1

im1-EXT

Installation instructions

Installation instructions

- Do not install the device in locations where it may be wet or damp. Also avoid locations with increased dust formation, high humidity or high ambient temperature.
- Avoid direct sunlight to prevent the device from overheating.
- Install or store this device out of the reach of children and do not allow persons unfamiliar with the device and these instructions to handle and operate the device.
- Use 4 screws with a suitable diameter to mount the device (see "Dimensions"). Fastening, screw type and screw length depend on the mounting ground.
- Use shielded Ethernet cables and a grounded PoE power supply only.
- Before using the device, ensure all cables are connected correctly and not damaged.
- To avoid mechanical stress on the sockets, it is recommended to provide a cable strain relief.
- Ensure a min. distance of 8 mm (0.31 in) to the housing or mounting plate (e.g. using spacer pins included in the extent of supply).
- The max. diameter for spacer pins is 9.1 mm (0.36 in) for plastic and 5.6 mm (0.22 in) for conductive materials.
- Ensure a min. distance of 30 mm (1.18 in) at the USB jack and RJ45 jack so that cables can be connected and disconnected when the device installed.
- Devices belonging to another earthing network must not be connected to the connectors of the device.

Safety instructions

- This device shall be installed or replaced by trained and qualified personnel only.
- Observe the country-specific standards for installation, mounting and configuration.
- Only use Commend accessories that comply with the device's technical specifications.
- All connected circuits shall fulfil the following requirements:
 - Safety Extra Low Voltage (SELV) and Limited Power Source (LPS) according to IEC/EN 60950-1 or
 - ES1, PS2 circuits and Annex Q (Limited Power Source) according to IEC/EN/UL 62368-1.
- Disconnect the power supply and the Ethernet cable from the device before carrying out any work on the device.
- All changes or modifications not expressly approved by the party responsible for compliance could void the user's authority to operate the equipment.
- This equipment has been tested and found to comply with the limits for a Class B digital device, pursuant to part 15 of the FCC Rules. These limits are designed to provide reasonable protection against harmful interference in a residential installation. This equipment generates, uses and can radiate radio frequency energy and, if not installed and used in accordance with the instructions, may cause harmful interference to radio communications. However, there is no guarantee that interference will not occur in a particular installation. If this equipment does cause harmful interference to radio or television reception, which can be determined by turning the equipment off and on, the user is encouraged to try to correct the interference by one or more of the following measures:
 - Reorient or relocate the receiving antenna.
 - Increase the separation between the equipment and receiver.
 - Connect the equipment into an outlet on a circuit different from that to which the receiver is connected.
 - Consult the dealer or an experienced radio/TV technician for help.

PRELIMINARY

Line lengths

- The maximum line length of Cat. 5 cabling in a LAN is 100 m (328 ft) – e.g. from switch to device.
- The maximum line length of an input (IN1 and IN2), an output (OUT1) and a loudspeaker connection is 30 m (98 ft).
- The maximum line length of the DC power supply connection is 30 m (98 ft).
- The maximum line length of the USB connection is 5 m (16 ft).

Access

The device can be accessed through IPv4 (DHCP), IPv6 (link-local) and zeroconf. For information on accessing the web interface, see the product manual.

Dimensions im1-EXT

Measuring units in mm (in), not to scale!

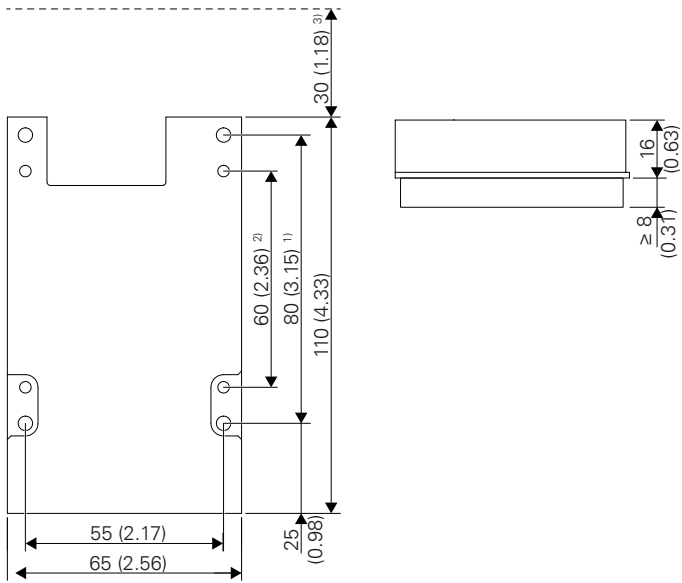

- ¹⁾ Mounting holes: \varnothing 4 mm (0.16 in)
- ²⁾ Mounting holes: \varnothing 3.2 mm (0.12 in)
- ³⁾ Protrusion for plugs

Output circuit

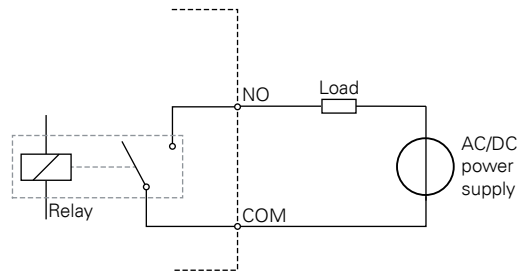

Input circuit

Connection example: one button per input

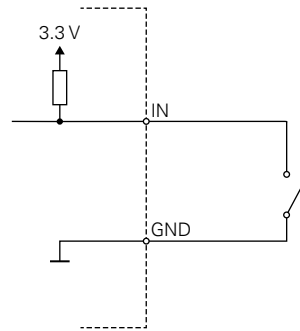

Connection example: multiple buttons (max. 15 buttons per input)

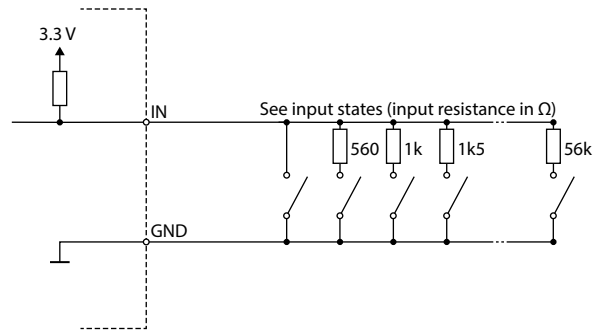

PRELIMINARY

Connection

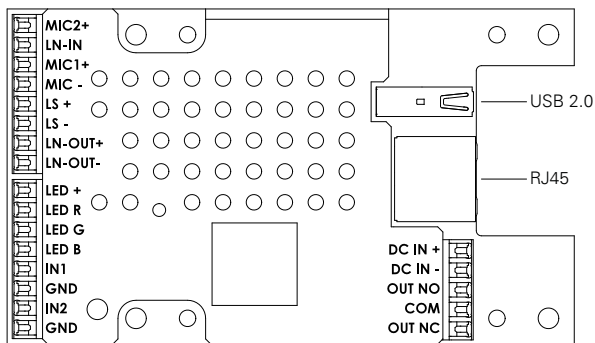

RGB-LED

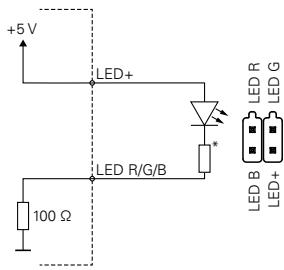

* It depends on the RGB LED if an optional resistor is required. No optional resistor is required for LED3.

LED intensity

To prevent the LED3 from reaching a too high temperature, it is recommended that the configured LED intensity is adapted to the maximum ambient temperature. If the LED intensity is not adapted to the maximum ambient temperature, this can reduce the lifespan of the LED3.

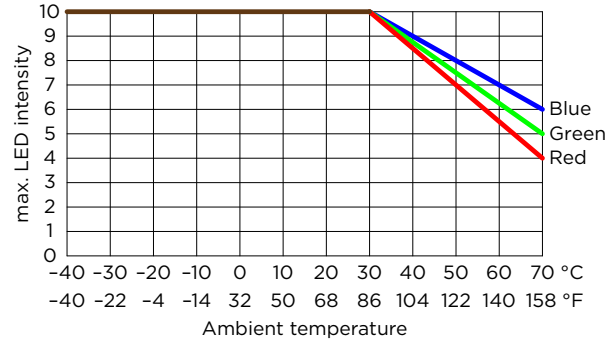

PRELIMINARY

Quality tested. Reliable. Smart.

COMMEND products are developed and manufactured by Commend International in Salzburg, Austria.

The development and manufacturing processes are certified in accordance with **EN ISO 9001:2015**.



The technical data contained herein has been provided solely for informational purposes and is not legally binding. Subject to change, technical or otherwise. lolP®, OpenDuplex® and Commend® are trademarks registered by Commend International GmbH. All other brands or product names are trademarks or registered trademarks of the respective owner and have not been specifically earmarked.

A strong worldwide network

COMMEND is represented all over the world by local Commend Partners and helps to improve security and communication with tailored Intercom solutions.

www.commend.com

